

MINIBLUE®

MAXIBLUE®

MEGABLUE®

 INSTALLATION INSTRUCTIONS

 INSTRUCTIONS D'INSTALLATION

 INSTRUCCIONES DE INSTALACION

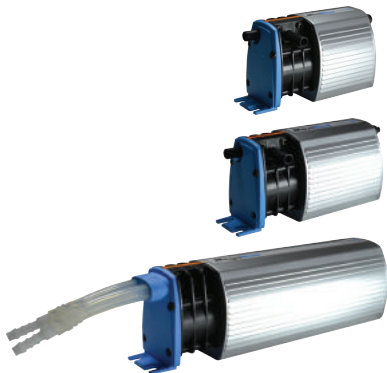

The BlueDiamond® pump range out performs other condensate pumps, can be mounted in any orientation and does exactly what you need it to do.

La gamme de pompes BlueDiamond® dépasse les performances d'autres pompes de condensation, peut être montée dans n'importe quelle orientation et fait exactement ce que vous attendez d'elle.

La serie de bombas BlueDiamond® rinde más que otras bombas de condensado, se puede montar en cualquier dirección y hace exactamente lo que usted necesita que haga.

MINIBLUE®
MAXIBLUE®



MEGABLUE®



S30-195/7

Manufactured by:



3 YEAR
WARRANTY



- Safety information
- Information de sécurité
- Precauciones de seguridad

3



- Warranty
- Garantie
- Garantía

4



- In the box
- Dans la boîte
- Material suministrado

5



- Mounting detail
- Notice de montage
- Acerca del montaje

6

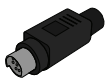

- Continuous running option
- Option fonctionnement continu

6

MINIBLUE®

MAXIBLUE®

MEGABLUE®



- Opción de funcionamiento continuo



- Installation
- Installation
- Instalación

7

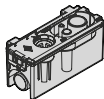

MINIBLUE® MAXIBLUE® MEGABLUE®

X



- Reservoir option
- Option réservoir
- Opción de depósito

8



MINIBLUE® MAXIBLUE® MEGABLUE®

X



- Drainstik® option
- Option Drainstik®
- Opción de Drainstik®

10

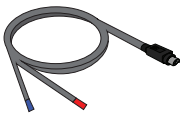

MINIBLUE® MAXIBLUE® MEGABLUE®



- Hot and cold sensor option
- Option sonde chaud et froid
- Opción Sensor frío y calor

12



MINIBLUE® MAXIBLUE® MEGABLUE®



- Water test
- Test eau
- Prueba de agua

14



MINIBLUE® MAXIBLUE® MEGABLUE®

X



- Alarm test
- Test alarme
- Test de alarma

15



- Alarm test
- Test alarme
- Test de alarma

14



Caution: Alarm lead must be connected to a class 2 circuit only –Do not connect to a load higher than 5A, 240v AC/DC.

Caution: This pump has been evaluated for use with water only.

Caution: Risk of electric shock: This pump has not been investigated for use in swimming pool or marine areas.

Caution: Since there is no water level sensing, the alarm relay will not operate with hot & cold sensing option.

Caution: For plenum installations use only metallic tubing for intake and discharge.

Warning: Be sure that the power to the unit is disconnected before installing, servicing or removing any component.

Warning: Do not store, install or operate this pump in a damp environment.

Warning: The unit must not be placed outside, immersed in water or exposed to frost.

Warning: All existing collection elements and fittings should be thoroughly cleaned before installing. Do not install if damaged.

Warning: Acceptable for indoor use only.



Avertissement: Le plomb de l'alarme doit être connectée à une classe de courant de 2 seulement - ne pas connecter à une charge plus haute que 5A, 240v AC/DC.

Avertissement: Cette pompe a été conçue pour une utilisation avec de l'eau uniquement.

Avertissement: Risque de décharge électrique : Cette pompe n'a pas été conçue pour une utilisation dans es piscines ou les zones marines.

Avertissement: Puisqu'il n'y a a pas de système de détection du niveau d'eau, le relais d'alarme ne fonctionnera pas avec l'option de sonde chaud et froid.

Avertissement: Pour les installations plénum utiliser uniquement des tubes métalliques pour le prélèvement et l'évacuation.

Avertissement: Soyez sûr que l'unité est débranchée avant l'installation, l'entretien ou l'enlèvement de n'importe quel composant.

Avertissement: Ne pas stocker, installer ou utiliser cette pompe dans un environnement humide.

A CONTINUÉ.....

Avertissement: La pompe ne doit pas être placée à l'extérieur, immergée dans l'eau ou exposée au gel.

Avertissement: Tous les éléments de récupération existants et des installations doivent être nettoyés à fond avant l'installation. N'installez pas si endommagé.

Avertissement: Convient pour une utilisation intérieure seulement.



Cuidado: El cable del alarma se debe conectar sólo a un circuito de la clase 2 - no conectar a un circuito con una carga mayor a 5A, 240V AC/DC.

Cuidado: Esta bomba ha sido diseñada exclusivamente para el uso con agua.

Cuidado: Peligro de descarga eléctrica. Esta bomba no ha sido diseñada para el uso en piscinas o en ámbito marinos.

Cuidado: Como la bomba no dispone de un sensor de nivel de agua, el relé del alarma no funcionará con la opción de sensor de frío y calor.

Cuidado: En la instalación del pleno, utilice únicamente tubos metálicos para la impulsión y aspiración.

Advertencia: Asegúrese de que la unidad está desconectada antes de instalar, mantener o quitar cualquier componente.

Advertencia: No almacene, instale o utilice esta bomba en ambientes húmedos.

Advertencia: La bomba no se debe utilizar en el exterior, sumergir en agua o exponer a heladas.

Advertencia: Todos los elementos colectores y los accesorios deben limpiarse antes de la instalación. No instalar componentes dañados.

Advertencia: Sólo utilizar en el interior.



The BlueDiamond® series of pumps are manufactured under Charles Austen Pumps strict quality control system. In the unlikely event of failure within 3 years from the date of purchase under normal usage, Charles Austen Pumps will repair the item free of charge subject to the following conditions:

- Charles Austen Pumps will decline any responsibility if the installation of the pump does not conform to these instructions and specifications.
- Any modifications to the unit will immediately void the warranty.
- We reserve the right to alter specifications without prior notice.



La série de pompes BlueDiamond® est fabriquée sous le contrôle d'un système de qualité très stricte de Charles Austen Pumps. Dans le cas peu probable d'une panne dans les 2 ans suivant la date d'achat dans des conditions d'utilisation normale, Charles Austen Pumps réparera l'article gratuitement selon les conditions suivantes

- Charles Austen déclinera toute responsabilité si l'installation de la pompe ne se conforme pas aux instructions et aux spécifications du cahier des charges.
- Toute modification apportée à la pompe annulera immédiatement la garantie.
- Nous nous réservons le droit de modifier le cahier des charges sans préavis.



Las bombas de la serie BlueDiamond® de Charles Austen Pumps se fabrican según estrictos estándares de calidad. En el caso poco probable de un problema de funcionamiento dentro de 2 años a partir de la fecha de la compra y a pesar de un uso normal, Charles Austen Pumps se encarga sin coste alguno de la reparación de la bomba bajo las siguientes condiciones:

- Charles Austen Pumps no se responsabiliza de daños causados por una instalación incorrecta debido a no seguir estas instrucciones.
- Cualquier modificación de la unidad invalida automáticamente la garantía.
- Reservado el derecho a modificar especificaciones sin previo aviso.

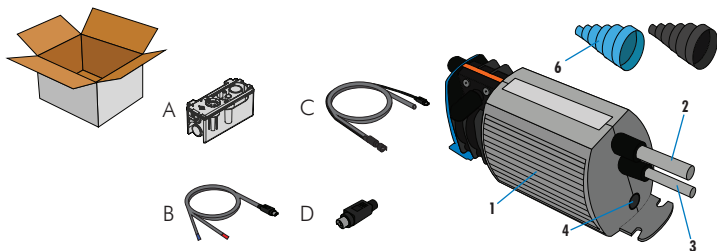

1. Pump (MINIBLUE, MAXIBLUE or MEGABLUE)
2. 2m (6' 7") mains lead
3. Zero volt alarm lead (Reservoir and DrainStik® only)
4. Sensor input socket
5. Sensing Option
(A) Reservoir OR
(B) Hot & cold sensor OR
(C) DrainStik® OR
(D) Continuous Running Plug
6. Stepped Connector x2 (Rigid & Flexible)



1. Pompes (MINIBLUE, MAXIBLUE or MEGABLUE)
2. Tuyau de 2m (6' 7")
3. Alarme de zéro volt (Réservoir et DrainStik® seulement)
4. Prise pour sonde
5. Option de détection
(A) Réservoir OU
(B) sonde chaud & froid OU
(C) DrainStik® OU
(D) prise de fonctionnement continu
6. Adaptateurs x2 (Rigide & flexible)



1. Bomba (MINIBLUE, MAXIBLUE or MEGABLUE)
2. 2m (6' 7") de cable eléctrico
3. Cable alarma cero voltios (Sólo Depósito y DrainStik®)
4. Toma entrada sensor
5. Opciones de sensor
(A) Depósito O
(B) Sensor calor & frío O
(C) DrainStik™ O
(D) Conexión funcionamiento continuo
6. Conector nivelado x2 (rígido y flexible)



	A (inches)
MEGABLUE®	9.21
MAXIBLUE®	5.59
MINIBLUE®	4.80

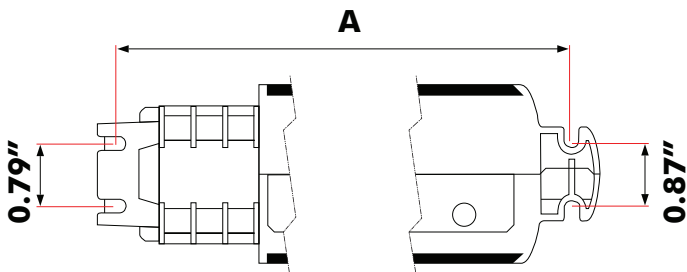

The pump may be mounted in any orientation but must be kept dry.



La pompe peut être montée dans n'importe quelle orientation, mais doit être gardée sèche.



La bomba se puede montar en cualquier orientación, pero se ha de mantener en seco.



MINIBLUE®





MAXIBLUE®



MEGABLUE®

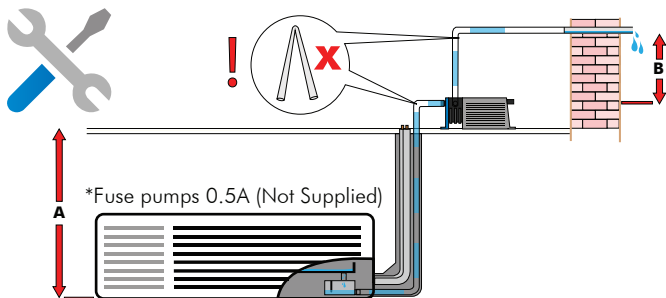



	FLOW	HEAD (A)	LIFT (B)	
MINIBLUE®	2.1 G/HR	23 FEET	16.5 FEET	0.5A
MAXIBLUE®	3.7 G/HR	23 FEET	16.5 FEET	0.5A
MEGABLUE®	13.2 G/HR	66.5 FEET	23 FEET	1.0A



Leave sufficient space around the pump unit to allow for cooling. Ensure that the pump is not more than **A** above the condensate outlet, and not more than **B** below the desired drainage point for the pump outlet. The pump can be mounted in any orientation but must be kept DRY. (See table above for **A** & **B**). Connect the discharge tube of the pump to a suitable drainage system. Secure with cable ties where necessary. A stepped adaptor is supplied to convert various tube diameters.



Laissez un espace suffisant autour de la pompe pour tenir compte du refroidissement. Assurez que la pompe n'est pas au-dessus de **A** pour la sortie de condensation et pas en-dessous de **B** pour le point de drainage désiré pour la sortie de la pompe. La pompe peut être montée dans n'importe quelle orientation, mais doit être gardée SÈCHE. (Voir le schéma ci-dessus pour **A** et **B**). Branchez le tube de refoulement de la pompe à un système de drainage approprié. Sécuriser avec un câble de fixation aux endroits où c'est nécessaire. Un adaptateur est fourni pour convertir les différents diamètres de tubes.



Deje suficiente espacio alrededor de la bomba para que se pueda enfriar. Asegúrese de que la bomba no se halle más de **A** por encima de la salida del condensado, y no más de **B** por debajo del punto de drenaje para la salida de la bomba. La bomba se puede montar en cualquier orientación, pero se ha de mantener en seco (para **A** & **B**, véase tabla de arriba). Conecte el tubo de descarga de la bomba a un sistema de drenaje adecuado. Segúrelo con bridas si es necesario. Se suministra con un adaptador nivelado para convertir los diferentes diámetros de tubo.

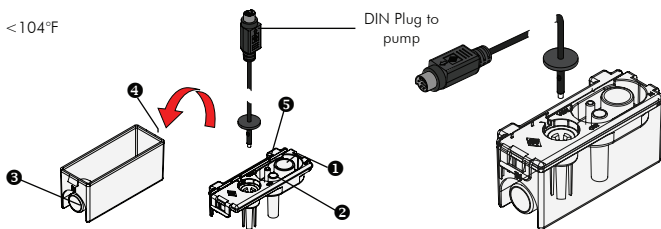

Choose to use either the top IN **1** and OUT **2** or side IN **3** and OUT **4** connections and fit blanking plugs to the unused ports. Connect the reservoir outlet (**2** or **4**) to the inlet of the pump & the flexible condensate inlet to the condensate tray hose. The reservoir is fitted with a vent tube **5**, which must remain unblocked with the free end secured above the full level of the condensate drip tray. Ensure the reservoir assembly is secured in a HORIZONTAL position using the screws supplied.



Choisissez soit l'entrée **1** et la sortie **2** sur le haut ou l'entrée **3** et la sortie **4** sur le côté et mettez les bouchons adaptés sur les ports inutilisés. Branchez la sortie du réservoir (**2** ou **4**) à l'aspiration de la pompe et l'entrée du réservoir au flexible reliant au bac de récupération des condensats. Le réservoir est adapté avec un tube de conduit **5**, qui doit rester dégagé avec la fin libre, sécurisée au-dessus du niveau plein du bac de récupération des eaux de condensation. Assurez que l'assemblage du réservoir est sécurisé dans une position HORIZONTAL en utilisant les vis fournies.



Utilice o las conexiones superiores IN **1** y OUT **2** o laterales IN **3** y OUT **4** y coloque los tapones ciegos en las conexiones no utilizadas. Conecte la salida del depósito (**2** o **4**) a la entrada de la bomba y la salida flexible del condensado a la manguera de la bandeja de condensados. El depósito dispone de un tubo de evacuación de aire **5**, cuyo extremo abierto debe estar a un nivel superior que el depósito. Asegúrese de que el depósito está en posición HORIZONTAL y bien fijado mediante los tornillos suministrados.



MINIBLUE®



MAXIBLUE®



MEGABLUE®



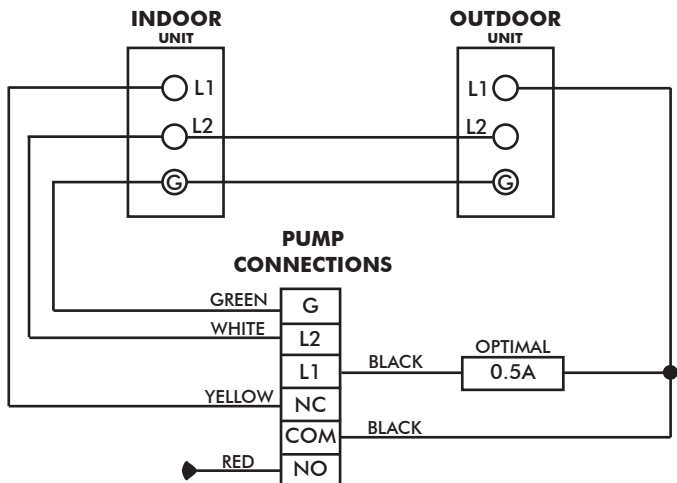

The alarm circuit is only applicable to product using the Reservoir and DrainStik sensing options. NC (Yellow) / NO (Red) and C (Black) will not operate when using the Temperature Sensing option

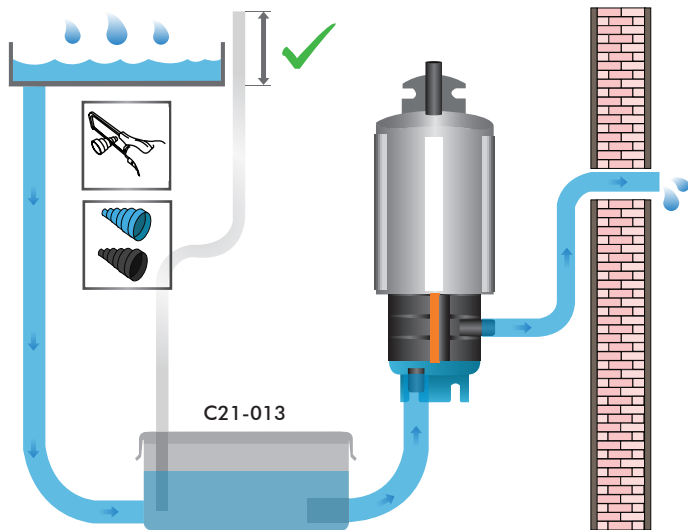

DrainStik® option / Option DrainStik® / Opción de DrainStik®

< 104°F



Insert the sensor **1** into the condensate tray pipe as shown and secure the hose **2** in position. The DrainStik® must be mounted vertically. Use the silicon hose provided.



Insérez le capteur **1** dans la conduite de condensation comme indiqué et sécurisez le tuyau **2** dans la position. Le DrainStik® doit être monté verticalement. Utilisez le tuyau en silicone fourni.



Inserte el sensor **1** en la manguera de la bandeja de condensados como indicado y coloque y fije la manguera **2** en su posición. El DrainStik® de ha de montar de forma vertical. Utilice la manguera de silicona suministrada.



MINIBLUE®



MAXIBLUE®



MEGABLUE®



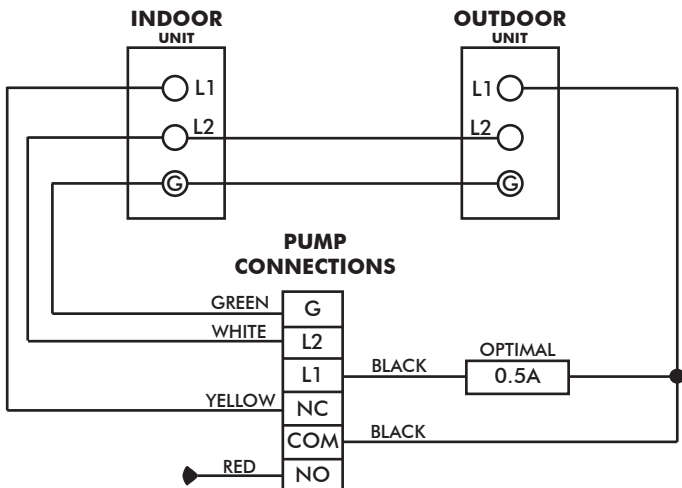

The alarm circuit is only applicable to product using the Reservoir and DrainStik sensing options. NC (Yellow) / NO (Red) and C (Black) will not operate when using the Temperature Sensing option

STEP ADAPTER:

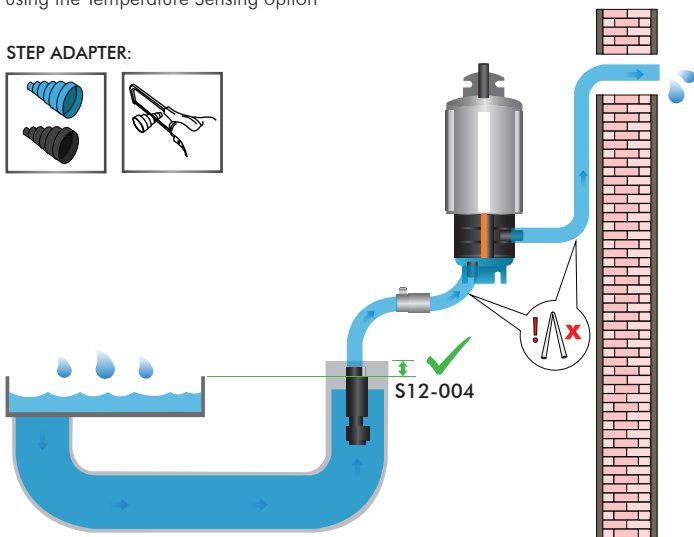
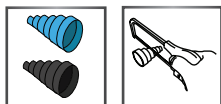

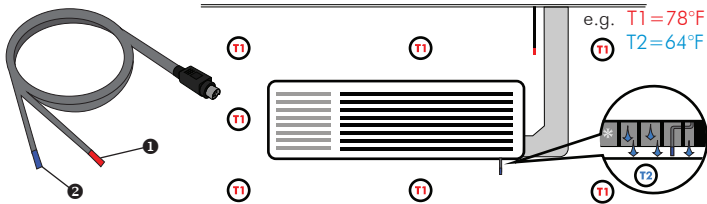

Position the hot thermistor sensor (Red ❶) in a suitable location at ambient air temperature. It is recommended that ceiling voids are avoided as these are usually at much higher temperatures. Place the cold thermistor sensor (Blue ❷) in the path of the air flow from the air conditioning unit.



Placez la sonde chaude (Rouge ❶) dans un emplacement approprié avec une température ambiante. Il est recommandé d'éviter les faux plafonds car ceux-ci sont habituellement à des températures beaucoup plus hautes. Placez la sonde froide (Bleue ❷) dans le chemin de l'écoulement d'air de l'unité de climatisation.



Coloque el sensor del termistor caliente (Rojo ❶) u en una ubicación adecuada a temperatura de ambiente. Para eso se recomienda no utilizar falsos techos, porque normalmente hay temperaturas más altas. Coloque el sensor del termistor frío (Azul ❷) v en el caudal de aire de la unidad de aire acondicionado.



MINIBLUE®



MAXIBLUE®



MEGABLUE®



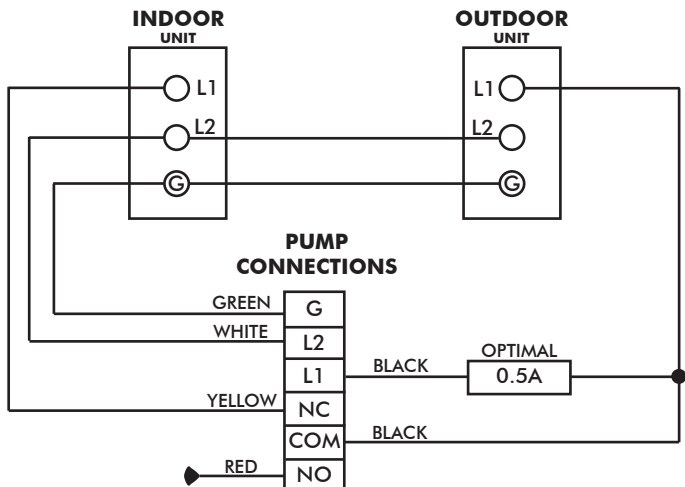

The alarm circuit is only applicable to product using the Reservoir and DrainStik sensing options. NC (Yellow) / NO (Red) and C (Black) will not operate when using the Temperature Sensing option. Can power pump without alarm.

STEP ADAPTER:

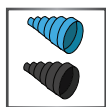

S12-002

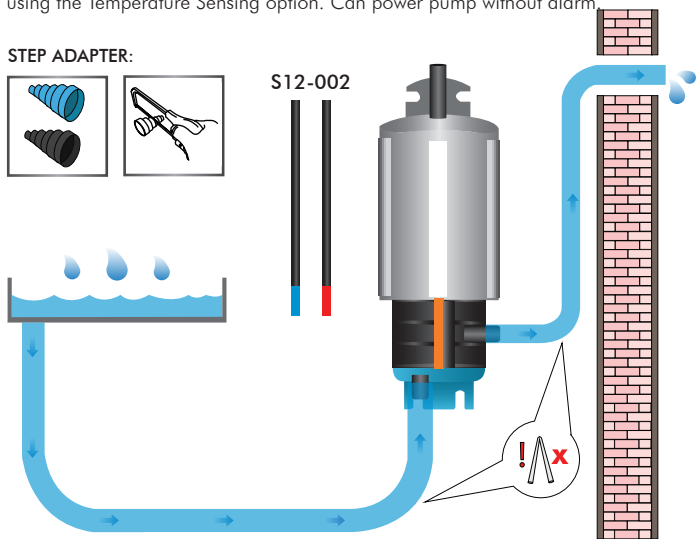

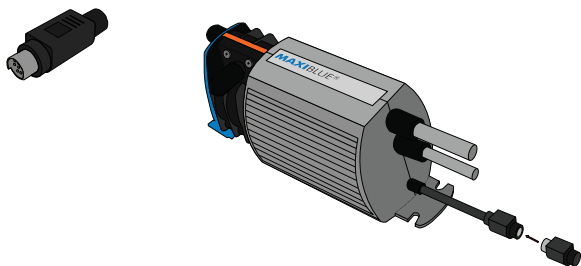

The continuous running (cooling signal) option allows the pump to run continuously. If powered from the same source as the A/C Unit, it will switch on / off with the A/C Unit. Connect the plug into the Sensor Input Socket before installation.

**The CR plug is a sensing option and is not included with standard pumps.*



L'option fonctionnement continu (signal froid) permet à la pompe de fonctionner continuellement. Si fonctionnement avec la même source que l'Unité A/C, la pompe s'allumera/s'éteindra en même temps. Branchez la fiche dans la prise pour capteur avant l'installation.

**La prise CR est une option de détection et n'est pas incluse dans les pompes standard.*



La opción de funcionamiento continuo (señal enfriamiento) permite que la bomba funcione sin interrupción. Cuando se alimenta de la misma fuente de alimentación que la unidad del aire acondicionado, se enciende / apaga con la unidad de A/C. Antes de comenzar con la instalación, conecte la clavija a la toma de entrada del sensor.

**El conector CR es una opción de detección y no se incluye con las bombas estándar.*

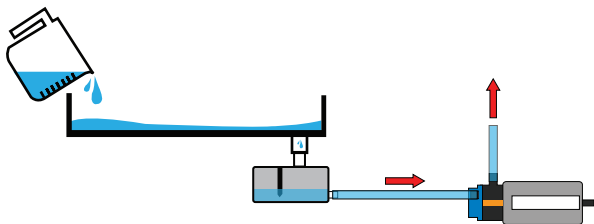

The water test ensures that the pump responds to the water level & that the pump switches off when dry. To test, slowly pour cold water into the tray until the pump switches on. Allow the pump to run and switch off. The pump should run for approximately 7 seconds after emptying the reservoir/condensate tray pipe.



Le test d'eau assure que la pompe répond au niveau d'eau et que la pompe s'éteint. Pour tester, verser lentement de l'eau froide dans le plateau jusqu'à ce que la pompe s'allume. Laisser le temps à la pompe de fonctionner puis éteindre. La pompe fonctionnera encore environ 7 secondes après avoir vidé la conduite du réservoir/condenseur.



La prueba de agua asegura que la bomba se enciende cuando hay cierto nivel de agua y que se apaga. Para la prueba, vierta lentamente agua fría en la bandeja hasta que la bomba se ponga en marcha. Déjala funcionar durante unos momentos y apagarse por sí misma. La bomba debería funcionar aproximadamente durante 7 segundos después de vaciar el depósito / el tubo de la bandeja de condensados.

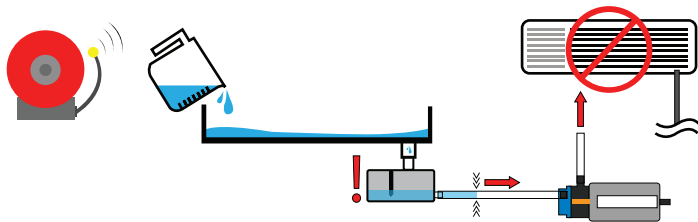

To ensure that the alarm connection is working, restrict the outlet of the reservoir hose and fill with water up to the high level sensor. The pump will turn on initially, then after a short delay the alarm relay will switch which can be detected using a multimeter or observing the shut down of the AC unit. Allow the water to exit the reservoir; the water should then be pumped away, and AC operation will restart.



Pour s'assurer que le signal d'alarme fonctionne, pincer le tuyau de sortie de réservoir et laisser le se remplir d'eau jusqu'au capteur de niveau haut. La pompe s'allumera, ensuite après un court délai le relais d'alarme commutera, l'utilisation détectée un multimètre ou une observation de l'arrêt de l'unité AC. Laissez l'eau quitter le réservoir; l'eau devrait alors être pompée loin et l'opération AC reprendra.



Para comprobar que la conexión del alarma está funcionando, tape la salida del depósito/tubo de y llénelo con agua hasta el sensor del nivel máximo. La bomba se pondrá inicialmente en marcha, después de un corto retraso, el relé del alarma saltará, que se notará o mediante el uso de un manómetro o el apagado automático de la unidad de aire acondicionado. Deje salir el agua del depósito; el agua entonces se debería eliminar mediante la bomba y el aire acondicionado volverá a ponerse en marcha.

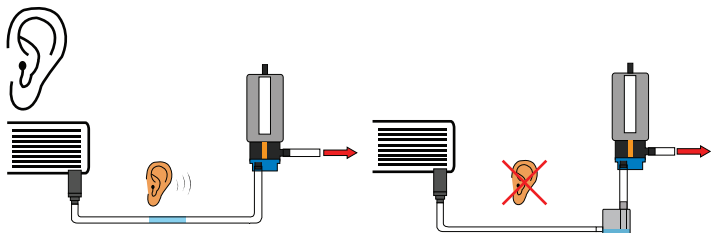

If the pump is installed remotely, occasionally water can become trapped in the u-bend at the lowest point of the system. Due to the pump's high flow rate, this can create a gurgling noise. It is recommended to fit the silencer supplied with the hot & cold sensor option. This must be fitted at the lowest point in the system, to reduce this noise.



Si la pompe est installée à distance, de temps en temps l'eau peut être prise au piège dans le coude au point le plus bas du système. En raison du haut débit de la pompe, ceci peut créer un bruit de "gargouillement". Il est recommandé d'adapter le silencieux fourni de l'option sonde chaud et froid. Il doit être installé au point le plus bas du système, pour réduire ce bruit.



Si la bomba está instalada a distancia, a veces el agua puede quedarse atrapada en la curva en el punto más bajo del sistema. Debido al caudal alto de la bomba, eso puede causar un ruido de borboteo. Es recomendable instalar el silenciador suministrado con la opción del sensor de frío y calor. Se tiene que instalar en el punto más bajo del sistema para reducir el ruido.

SENSING OPTIONS

	MINIBLUE®	MAXIBLUE®	MEGABLUE®
TEMPERATURE SENSOR S12-002	✓	✓	✓
DRAINSTIK® S12-004		✓	✓
CR PLUG P02-048	✓	✓	✓
MAXIBLUE® & MICROBLUE® RESERVOIR C21-013		✓	
MEGABLUE® RESERVOIR C21-008			✓

ACCESSORY OPTIONS

	MICROBLUE™	MAXIBLUE®	MEGABLUE®
5M CABLE EXTENTION C13-103	✓	✓	✓
RIGID STEP ADAPTER C01-226	✓	✓	✓
FLEXI STEP ADAPTER C01-231	✓	✓	✓
MULTITANK C21-014		✓	✓
ELBOW KIT - WHITE T18-007		✓	
MOUNTING FEET F10-011	✓	✓	✓
FASCIA KIT T18-016			

MINIBLUE®



TUBING SIZE



MAXIBLUE[®]



TUBING SIZE

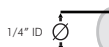

BRAIDED



MEGABLUE®



BLUEDIAMOND® PUMP SELECTOR GUIDE	INDUSTRY		UNIT			PERFORMANCE				INSTALLATION		
	AIR CONDITIONING	REFRIGERATION	0-18,000 BTU	18,000 - 48,000 BTU	48,000 - 170,000 BTU	MAX FLOW (G/HR)	MAX HEAD (FT)	MAX LIFT (FT)	SOUND (DBA)	IN UNIT	DUCTING	REMOVED
MICROBLUE™	✓		✓			1.3	16	6	17	✓	✓	✓
MAXIBLUE®	✓	✓		✓		3.7	23	16.5	21		✓	✓
MEGABLUE®	✓	✓			✓	13.2	66.5	23	23			✓

Distributed by:-

BLUEDIAMOND
PUMPS INC

Web: www.bluediamondpumps.com

4850 Golden Parkway, Suite B, 409

Buford, GA, 30518, USA

Tel: +1 770 831 1122

Email: info@bluediamondpumps.com